

Ship To

Recipient

Address

Phone

Fax

Contact

Offer Date

Offer Validity

PR Number

Offer Number

| Item # | Model # | Description | QTY | U/P (SR) | T/P (SR) |
|--------|---------|-------------|-----|----------|----------|
|--------|---------|-------------|-----|----------|----------|

# ZEPF GmbH -Germany Surgical Instruments



## Laryngology Instruments

آلات جراحية لطب الحنجرة

composed of below items.



Brochure

CLICK



Manufacturer: Zepf GmbH – Germany







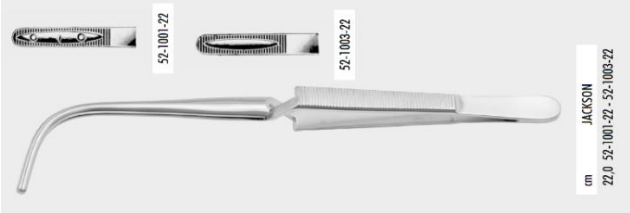

### ABD MIDEAST GENERAL TRADING

Level 41, Emirates Towers Sheikh Zayed Road. Dubai, UAE PO Box 31303  
Tel: +971 4 319 7867  
Fax: +971 4 319 7897

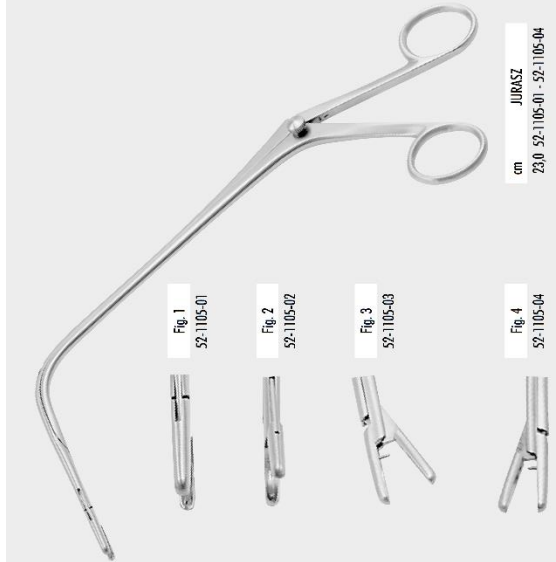

Click for Links

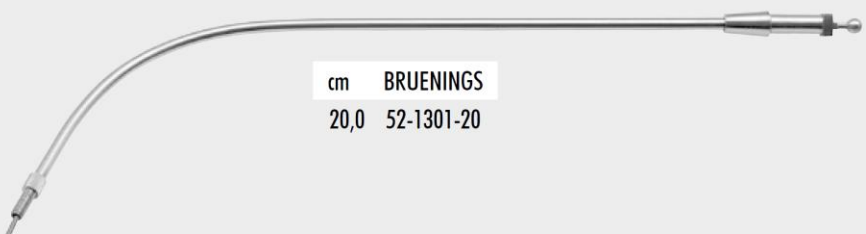
| Item # | Model #    | Description  | QTY | U/P (SR) | T/P (SR) |
|--------|------------|--|-----|----------|----------|
| 8131   | 52-1001-22 | <b>JACKSON tampon forceps 1x2pins</b><br>  | 01  |          |          |
| 8132   | 52-1003-22 | <b>JACKSON tampon forceps</b>  | 01  |          |          |
| 8133   | 52-1101-18 | <b>FRAENKEL lar. polypus forceps</b><br>   | 01  |          |          |
| 8134   | 52-1105-01 | <b>JURASZ lar.polyp.forceps fig.1</b><br> | 01  |          |          |
| 8135   | 52-1105-02 | <b>JURASZ lar.polyp.forceps fig.2</b>  | 01  |          |          |
| 8136   | 52-1105-03 | <b>JURASZ lar.polyp.forceps fig.3</b>  | 01  |          |          |
| 8137   | 52-1105-04 | <b>JURASZ lar.polyp.forceps fig.4</b>  | 01  |          |          |
| 8138   | 52-1201-24 | <b>REICHERT epiglottis retractor</b><br> | 01  |          |          |

| Item # | Model # | Description  | QTY | U/P (SR) | T/P (SR) |
|--------|---------|--|-----|----------|----------|
|        |         |  <p>cm BRUENINGS<br/>20,0 52-1301-20</p> |     |          |          |
|        |         |  <p>HUBER<br/>52-1300-00</p>            |     |          |          |
|        |         |  <p>cm BRUENINGS<br/>20,0 52-1302-20</p> |     |          |          |
|        |         | <p>30,0 52-1302-30</p>   |     |          |          |
|        |         | <p>40,0 52-1302-40</p>   |     |          |          |
|        |         | <p>50,0 52-1302-50</p>   |     |          |          |
|        |         | <p>60,0 52-1302-60</p>   |     |          |          |





























|      |            |                                |    |  |  |
|------|------------|--------------------------------|----|--|--|
| 8139 | 52-1300-00 | HUBER universal handle         | 01 |  |  |
| 8140 | 52-1301-20 | BRUENINGS extens.tube cvd.20cm | 01 |  |  |
| 8141 | 52-1302-20 | BRUENINGS extens.tube str.20cm | 01 |  |  |
| 8142 | 52-1302-30 | BRUENINGS extens.tube str.30cm | 01 |  |  |
| 8143 | 52-1302-40 | BRUENINGS extens.tube str.40cm | 01 |  |  |
| 8144 | 52-1302-50 | BRUENINGS extens.tube str.50cm | 01 |  |  |
| 8145 | 52-1302-60 | BRUENINGS extens.tube str.60cm | 01 |  |  |

#### ABD MIDEAST GENERAL TRADING

Level 41, Emirates Towers Sheikh Zayed Road. Dubai, UAE PO Box 31303  
Tel: +971 4 319 7867  
Fax: +971 4 319 7897



Click for Links

| Item # | Model #   | Description   | QTY        | U/P (SR)  | T/P (SR)  |
|--------|---|---|------------|---|---|
|        |    |    |            |   |    |
|        | FRAENKEL<br>52-1500-00  | SEIFFERT<br>52-1502-00  |            |   | FRAENKEL<br>52-1504-00  |
|        |   |   |            |  | 52-1508-02  |
|        |   |   |            |  | 52-1508-03  |
|        |    |    |            |   |    |
|        | SCHEINMANN<br>52-1505-00  | SCHEINMANN<br>52-1507-00  |            |   | BRUENINGS<br>52-1508-02 - 52-1508-03  |
|        |    |   |            |   |    |
|        | 52-1600-02  |   |            |   | 52-1604-01  |
|        |    |   |            |   |    |
|        | 52-1600-03  |   |            |   | 52-1604-02  |
|        |   |   |            |   |   |
|        | BRUENINGS<br>52-1600-02 - 52-1600-03  | LANGE<br>52-1602-00   |            |   | KRAUSE<br>52-1604-01 - 52-1604-02   |
|        |   |  | 52-1608-01 |  | 52-1608-02  |
|        |  | 52-1608-03  |            |  | 52-1608-04  |
|        |  |  |            |   |  |
|        | KRAUSE<br>52-1606-00  | CORDES<br>52-1608-01 - 52-1608-04   |            |   | SCHUMACHER<br>52-1700-00  |
|        |  |   |            |   |   |
|        | 52-1702-01  |   |            |   |   |
|        |  |  |            |   |   |
|        | 52-1702-02  |   |            |   |   |
|        |  |  |            |   |  |
|        | CORDES<br>52-1702-01 - 52-1702-02   | CORDES<br>52-1704-00  |            |   | ROSENBERG<br>52-1706-00   |

#### ABD MIDEAST GENERAL TRADING

Level 41, Emirates Towers Sheikh Zayed Road. Dubai, UAE PO Box 31303  
Tel: +971 4 319 7867  
Fax: +971 4 319 7897





| Item # | Model #    | Description                  | QTY | U/P (SR) | T/P (SR) |
|--------|------------|------------------------------|-----|----------|----------|
| 8146   | 52-1500-00 | FRAENKEL forceps tip         | 01  |          |          |
| 8147   | 52-1502-00 | SEIFFERT forceps tip         | 01  |          |          |
| 8148   | 52-1504-00 | FRAENKEL forceps tip         | 01  |          |          |
| 8149   | 52-1505-00 | SCHEINMANN forceps tip       | 01  |          |          |
| 8150   | 52-1507-00 | SCHEINMANN forceps tip       | 01  |          |          |
| 8151   | 52-1508-02 | BRUENINGS forceps tip fig. 2 | 01  |          |          |
| 8152   | 52-1508-03 | BRUENINGS forceps tip fig. 3 | 01  |          |          |
| 8153   | 52-1600-02 | BRUENINGS forceps tip fig. 2 | 01  |          |          |
| 8154   | 52-1600-03 | BRUENINGS forceps tip fig. 3 | 01  |          |          |
| 8155   | 52-1602-00 | LANGE forceps tip            | 01  |          |          |
| 8156   | 52-1604-01 | KRAUSE forceps tip fig. 1    | 01  |          |          |
| 8157   | 52-1604-02 | KRAUSE forceps tip fig. 2    | 01  |          |          |
| 8158   | 52-1606-00 | KRAUSE forceps tip           | 01  |          |          |
| 8159   | 52-1608-01 | CORDES forceps tip fig. 1    | 01  |          |          |
| 8160   | 52-1608-02 | CORDES forceps tip fig. 2    | 01  |          |          |
| 8161   | 52-1608-03 | CORDES forceps tip fig. 3    | 01  |          |          |
| 8162   | 52-1608-04 | CORDES forceps tip fig. 4    | 01  |          |          |
| 8163   | 52-1700-00 | SCHUMACHER forceps tip       | 01  |          |          |
| 8164   | 52-1702-01 | CORDES forceps tip fig. 1    | 01  |          |          |
| 8165   | 52-1702-02 | CORDES forceps tip fig. 2    | 01  |          |          |
| 8166   | 52-1704-00 | CORDES forceps tip           | 01  |          |          |
| 8167   | 52-1706-00 | ROSENBERG forceps tip        | 01  |          |          |

#### ABD MIDEAST GENERAL TRADING

Level 41, Emirates Towers Sheikh Zayed Road. Dubai, UAE PO Box 31303  
Tel: +971 4 319 7867  
Fax: +971 4 319 7897

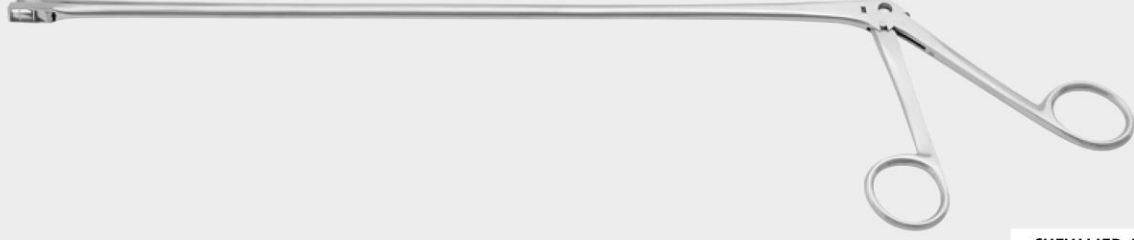

| Item #   | Model #    | Description                           | QTY        | U/P (SR)   | T/P (SR)   |            |            |
|--|------------|---------------------------------------|------------|------------|------------|------------|------------|
|  <p style="text-align: right;">CHEVALIER-JACKSON<br/>52-2300-01 - 52-2600-07</p> |            |                                       |            |            |            |            |            |
|    |            |                                       |            |            |            |            |            |
| cm   | Fig. 1     | Fig. 2                                | Fig. 3     | Fig. 4     | Fig. 5     | Fig. 6     | Fig. 7     |
| 30,0   | 52-2300-01 | 52-2300-02                            | 52-2300-03 | 52-2300-04 | 52-2300-05 | 52-2300-06 | 52-2300-07 |
| 40,0   | 52-2400-01 | 52-2400-02                            | 52-2400-03 | 52-2400-04 | 52-2400-05 | 52-2400-06 | 52-2400-07 |
| 50,0   | 52-2500-01 | 52-2500-02                            | 52-2500-03 | 52-2500-04 | 52-2500-05 | 52-2500-06 | 52-2500-07 |
| 60,0   | 52-2600-01 | 52-2600-02                            | 52-2600-03 | 52-2600-04 | 52-2600-05 | 52-2600-06 | 52-2600-07 |
| 8168   | 52-2300-01 | <b>CHEV.JACKSON forcps.30cm fig.1</b> |            | 01         |            |            |            |
| 8169   | 52-2300-02 | <b>CHEV.JACKSON forcps.30cm fig.2</b> |            | 01         |            |            |            |
| 8170   | 52-2300-03 | <b>CHEV.JACKSON forcps.30cm fig.3</b> |            | 01         |            |            |            |
| 8171   | 52-2300-04 | <b>CHEV.JACKSON forcps.30cm fig.4</b> |            | 01         |            |            |            |
| 8172   | 52-2300-05 | <b>CHEV.JACKSON forcps.30cm fig.5</b> |            | 01         |            |            |            |
| 8173   | 52-2300-06 | <b>CHEV.JACKSON forcps.30cm fig.6</b> |            | 01         |            |            |            |
| 8174   | 52-2300-07 | <b>CHEV.JACKSON forcps.30cm fig.7</b> |            | 01         |            |            |            |
| 8175   | 52-2400-01 | <b>CHEV.JACKSON forcps.40cm fig.1</b> |            | 01         |            |            |            |
| 8176   | 52-2400-02 | <b>CHEV.JACKSON forcps.40cm fig.2</b> |            | 01         |            |            |            |
| 8177   | 52-2400-03 | <b>CHEV.JACKSON forcps.40cm fig.3</b> |            | 01         |            |            |            |
| 8178   | 52-2400-04 | <b>CHEV.JACKSON forcps.40cm fig.4</b> |            | 01         |            |            |            |
| 8179   | 52-2400-05 | <b>CHEV.JACKSON forcps.40cm fig.5</b> |            | 01         |            |            |            |
| 8180   | 52-2400-06 | <b>CHEV.JACKSON forcps.40cm fig.6</b> |            | 01         |            |            |            |
| 8181   | 52-2400-07 | <b>CHEV.JACKSON forcps.40cm fig.7</b> |            | 01         |            |            |            |

#### ABD MIDEAST GENERAL TRADING

Level 41, Emirates Towers Sheikh Zayed Road. Dubai, UAE PO Box 31303  
Tel: +971 4 319 7867  
Fax: +971 4 319 7897



Click for Links



| Item # | Model #    | Description                    | QTY | U/P (SR) | T/P (SR) |
|--------|------------|--------------------------------|-----|----------|----------|
| 8182   | 52-2500-01 | CHEV.JACKSON forcps.50cm fig.1 | 01  |          |          |
| 8183   | 52-2500-02 | CHEV.JACKSON forcps.50cm fig.2 | 01  |          |          |
| 8184   | 52-2500-03 | CHEV.JACKSON forcps.50cm fig.3 | 01  |          |          |
| 8185   | 52-2500-04 | CHEV.JACKSON forcps.50cm fig.4 | 01  |          |          |
| 8186   | 52-2500-05 | CHEV.JACKSON forcps.50cm fig.5 | 01  |          |          |
| 8187   | 52-2500-06 | CHEV.JACKSON forcps.50cm fig.6 | 01  |          |          |
| 8188   | 52-2500-07 | CHEV.JACKSON forcps.50cm fig.7 | 01  |          |          |
| 8189   | 52-2600-01 | CHEV.JACKSON forcps.60cm fig.1 | 01  |          |          |
| 8190   | 52-2600-02 | CHEV.JACKSON forcps.60cm fig.2 | 01  |          |          |
| 8191   | 52-2600-03 | CHEV.JACKSON forcps.60cm fig.3 | 01  |          |          |
| 8192   | 52-2600-04 | CHEV.JACKSON forcps.60cm fig.4 | 01  |          |          |
| 8193   | 52-2600-05 | CHEV.JACKSON forcps.60cm fig.5 | 01  |          |          |
| 8194   | 52-2600-06 | CHEV.JACKSON forcps.60cm fig.6 | 01  |          |          |
| 8195   | 52-2600-07 | CHEV.JACKSON forcps.60cm fig.7 | 01  |          |          |

#### ABD MIDEAST GENERAL TRADING

Level 41, Emirates Towers Sheikh Zayed Road. Dubai, UAE PO Box 31303  
Tel: +971 4 319 7867  
Fax: +971 4 319 7897

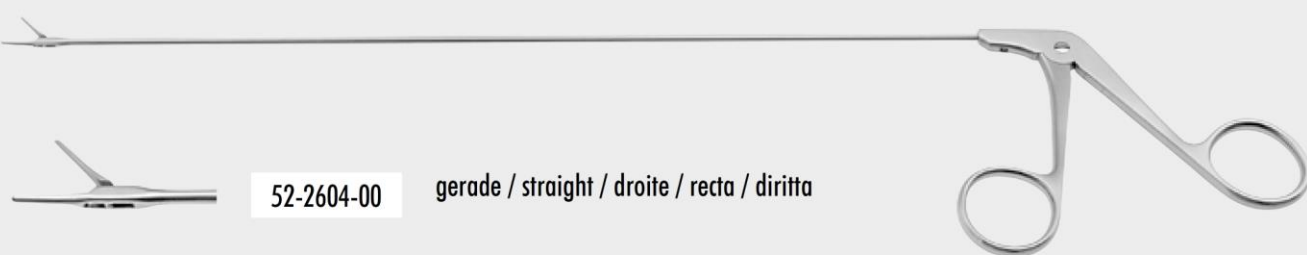

Click for Links

| Item # | Model #    | Description  | QTY | U/P (SR) | T/P (SR) |
|--------|------------|--|-----|----------|----------|
|        |            |  |     |          |          |
|        | 52-2604-00 | gerade / straight / droite / recta / diritta                                       |     |          |          |
|        | 52-2604-01 | links / left / à gauche / a la izquierda / sinistra                                |     |          |          |
|        | 52-2604-02 | rechts / right / à droite / a la derecha / destra                                  |     |          |          |
|        | 52-2604-04 | gerade / straight / droite / recta / diritta                                       |     |          |          |
|        | 52-2604-05 | links / left / à gauche / a la izquierda / sinistra                                |     |          |          |
|        | 52-2604-06 | rechts / right / à droite / a la derecha / destra                                  |     |          |          |
|        | 52-2604-07 | aufwärts / upward / courbe vers le haut / curva hacia arriba / curva in alto       |     |          |          |
|        | 52-2604-10 | gerade / straight / droite / recta / diritta                                       |     |          |          |
|        | 52-2604-11 | links / left / à gauche / a la izquierda / sinistra                                |     |          |          |
|        | 52-2604-12 | rechts / right / à droite / a la derecha / destra                                  |     |          |          |
|        | 52-2604-13 | aufwärts / upward / courbe vers le haut / curva hacia arriba / curva in alto       |     |          |          |
| 8196   | 52-2604-00 | <b>micro grasp.lar.fcps.24cm str.</b>  | 01  |          |          |
| 8197   | 52-2604-01 | <b>micro grasp.lar.fcps.24cm left</b>  | 01  |          |          |
| 8198   | 52-2604-02 | <b>micro grasp.lar.fcps.24cm rigt</b>  | 01  |          |          |
| 8199   | 52-2604-04 | <b>forceps cup microlar.24cm str.</b>  | 01  |          |          |

#### ABD MIDEAST GENERAL TRADING

Level 41, Emirates Towers Sheikh Zayed Road. Dubai, UAE PO Box 31303  
Tel: +971 4 319 7867  
Fax: +971 4 319 7897



Click for Links





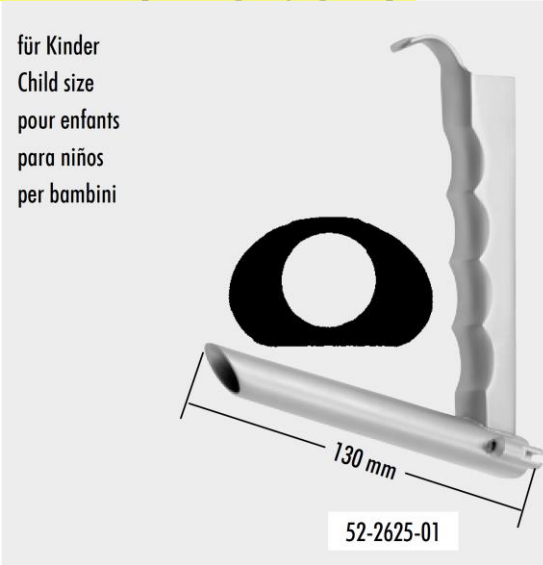

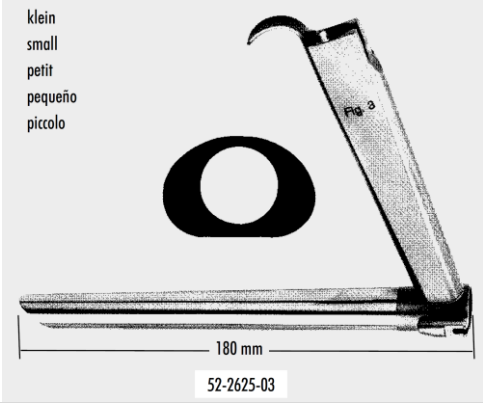
| Item # | Model #    | Description  | QTY | U/P (SR) | T/P (SR) |
|--------|------------|--|-----|----------|----------|
| 8200   | 52-2604-05 | forceps cup microlar.24cm left   | 01  |          |          |
| 8201   | 52-2604-06 | forceps cup microlar.24cm right  | 01  |          |          |
| 8202   | 52-2604-07 | forceps cup microlar.24cm upw.   | 01  |          |          |
| 8203   | 52-2604-10 | scissors microlar.24cm strght.   | 01  |          |          |
| 8204   | 52-2604-11 | scissors microlar.24cm left  | 01  |          |          |
| 8205   | 52-2604-12 | scissors microlar.24cm right   | 01  |          |          |
| 8206   | 52-2604-13 | scissors microlar.24cm upward  | 01  |          |          |
| 8207   | 52-2625-01 | <b>KLEINSASSER operating laryngoscope</b><br>für Kinder<br>Child size<br>pour enfants<br>para niños<br>per bambini   | 01  |          |          |
| 8208   | 52-2625-02 | <b>KLEINSASSER operating laryngoscope</b><br>für die vordere Kommissur<br>Anterior Commissure<br>pour la commissure antérieure<br>para la comisura anterior<br>per la commissura anteriore | 01  |          |          |

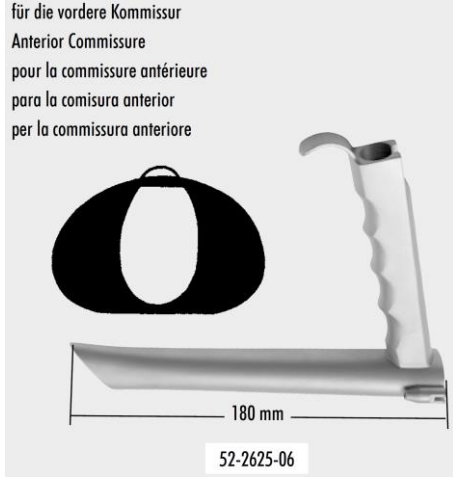
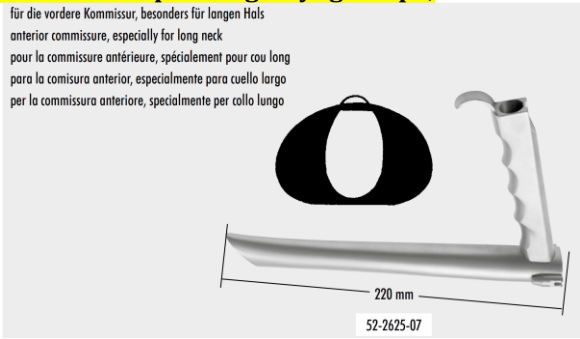

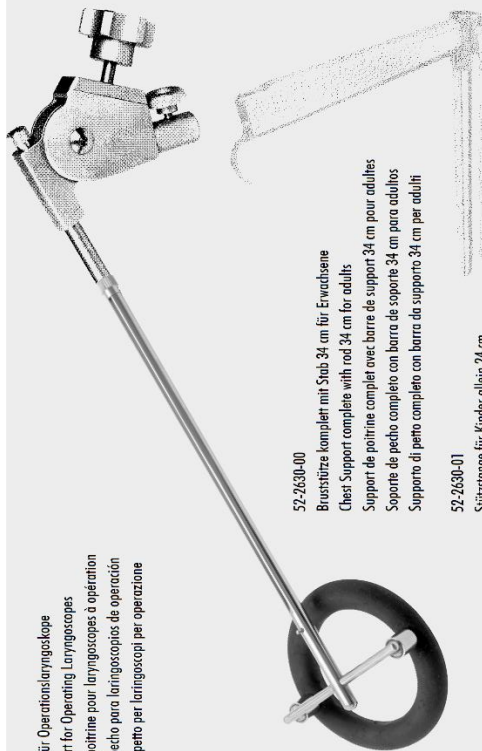
| Item # | Model #    | Description   | QTY | U/P (SR) | T/P (SR) |
|--------|------------|---|-----|----------|----------|
| 8209   | 52-2625-03 | <p><b>KLEINSASSER operating layngoscope small</b></p> <p>klein<br/>small<br/>petit<br/>pequeño<br/>piccolo</p>  <p>180 mm</p> <p>52-2625-03</p>   | 01  |          |          |
| 8210   | 52-2625-04 | <p><b>KLEINSASSER operating laryngoscope</b></p> <p>mittlere Größe<br/>medium size<br/>grandeur moyenne<br/>tamaño mediano<br/>grandezza media</p>  <p>180 mm</p> <p>52-2625-04</p>  | 01  |          |          |
| 8211   | 52-2625-05 | <p><b>KLEINSASSER operating laryngoscope</b></p> <p>groß, für Erwachsene<br/>large size, adult<br/>grand modèle, pour adultes<br/>modelo grande, para adultos<br/>modello grande, per adulti</p>  <p>180 mm</p> <p>52-2625-05</p> | 01  |          |          |

| Item # | Model #    | Description  | QTY | U/P (SR) | T/P (SR) |
|--------|------------|--|-----|----------|----------|
| 8212   | 52-2625-06 | <p><b>KLEINSASSER operating laryngoscope 18cm</b></p> <p>für die vordere Kommissur<br/>Anterior Commissure<br/>pour la commissure antérieure<br/>para la comisura anterior<br/>per la commissura anteriore</p>  <p>180 mm</p> <p>52-2625-06</p>   | 01  |          |          |
| 8213   | 52-2625-07 | <p><b>KLEINSASSER operating laryngoscope,</b></p> <p>für die vordere Kommissur, besonders für langen Hals<br/>anterior commissure, especially for long neck<br/>pour la commissure antérieure, spécialement pour cou long<br/>para la comisura anterior, especialmente para cuello largo<br/>per la commissura anteriore, specialmente per collo lungo</p>  <p>220 mm</p> <p>52-2625-07</p> | 01  |          |          |

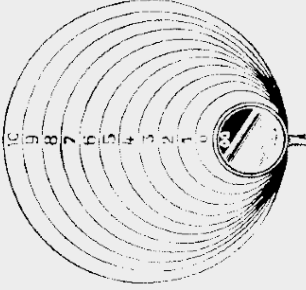
| Item # | Model #    | Description   | QTY | U/P (SR) | T/P (SR) |
|--------|------------|---|-----|----------|----------|
|        |            |  <p>Bruststütze für Operationslaryngoskope<br/>Chest Support for Operating Laryngoscopes<br/>Support de poitrine pour laryngoscopes à opération<br/>Soporte de pecho para laringoscopios de operación<br/>Supporto di petto per laringoscopi per operazione</p> <p>52-2630-00<br/>Bruststütze komplett mit Stab 34 cm für Erwachsene<br/>Chest Support complete with rod 34 cm for adults<br/>Support de poitrine complet avec barre de support 34 cm pour adultes<br/>Soporte de pecho completo con barra de soporte 34 cm para adultos<br/>Supporto di petto completo con barra da supporto 34 cm per adulti</p> <p>52-2630-01<br/>Stützstange für Kinder allein 24 cm<br/>Rod only child size 24 cm<br/>Barre de support seul pour enfants 24 cm<br/>Barra de soporte suelta para niños 24 cm<br/>Barra da supporto per bambini solo 24 cm</p> |     |          |          |
| 8214   | 52-2630-00 | <b>RIECKER KLEINSASSER chest support</b>  | 01  |          |          |
| 8215   | 52-2630-01 | <b>rod for children only 24 cm</b>  | 01  |          |          |
| 8216   | 52-2640-01 | <b>fiber optic light carrier for use with</b>   | 01  |          |          |
| 8217   | 52-2640-02 | <b>fiber optic light carrier f. 52-2625-03</b>  | 01  |          |          |
| 8218   | 52-2640-03 | <b>fiber optic light carrier f. 52-2625-07</b>  | 01  |          |          |
| 8219   | 52-2650-01 | <b>injection cannula for positive pressure</b>  | 01  |          |          |

| Item # | Model #    | Description   | QTY  | U/P (SR)   | T/P (SR) |   |    |   |   |    |   |    |   |    |   |    |   |    |   |    |   |    |   |    |   |    |   |    |    |    |  |  |  |
|--------|------------|---|------|--|----------|---|----|---|---|----|---|----|---|----|---|----|---|----|---|----|---|----|---|----|---|----|---|----|----|----|--|--|--|
|        |            | <br><br>   |      | 52-2702-06 - 52-2702-30  |          |   |    |   |   |    |   |    |   |    |   |    |   |    |   |    |   |    |   |    |   |    |   |    |    |    |  |  |  |
|        |            | <table border="1"> <thead> <tr> <th>Fig.</th> <th>mm</th> </tr> </thead> <tbody> <tr><td>000</td><td>6</td></tr> <tr><td>00</td><td>8</td></tr> <tr><td>0</td><td>10</td></tr> <tr><td>1</td><td>12</td></tr> <tr><td>2</td><td>14</td></tr> <tr><td>3</td><td>16</td></tr> <tr><td>4</td><td>18</td></tr> <tr><td>5</td><td>20</td></tr> <tr><td>6</td><td>22</td></tr> <tr><td>7</td><td>24</td></tr> <tr><td>8</td><td>26</td></tr> <tr><td>9</td><td>28</td></tr> <tr><td>10</td><td>30</td></tr> </tbody> </table> | Fig. | mm   | 000      | 6 | 00 | 8 | 0 | 10 | 1 | 12 | 2 | 14 | 3 | 16 | 4 | 18 | 5 | 20 | 6 | 22 | 7 | 24 | 8 | 26 | 9 | 28 | 10 | 30 |  | Mit Griff<br>with handle<br>avec manche<br>con mango<br>con manico |  |
| Fig.   | mm         |   |      |  |          |   |    |   |   |    |   |    |   |    |   |    |   |    |   |    |   |    |   |    |   |    |   |    |    |    |  |  |  |
| 000    | 6          |   |      |  |          |   |    |   |   |    |   |    |   |    |   |    |   |    |   |    |   |    |   |    |   |    |   |    |    |    |  |  |  |
| 00     | 8          |   |      |  |          |   |    |   |   |    |   |    |   |    |   |    |   |    |   |    |   |    |   |    |   |    |   |    |    |    |  |  |  |
| 0      | 10         |   |      |  |          |   |    |   |   |    |   |    |   |    |   |    |   |    |   |    |   |    |   |    |   |    |   |    |    |    |  |  |  |
| 1      | 12         |   |      |  |          |   |    |   |   |    |   |    |   |    |   |    |   |    |   |    |   |    |   |    |   |    |   |    |    |    |  |  |  |
| 2      | 14         |   |      |  |          |   |    |   |   |    |   |    |   |    |   |    |   |    |   |    |   |    |   |    |   |    |   |    |    |    |  |  |  |
| 3      | 16         |   |      |  |          |   |    |   |   |    |   |    |   |    |   |    |   |    |   |    |   |    |   |    |   |    |   |    |    |    |  |  |  |
| 4      | 18         |   |      |  |          |   |    |   |   |    |   |    |   |    |   |    |   |    |   |    |   |    |   |    |   |    |   |    |    |    |  |  |  |
| 5      | 20         |   |      |  |          |   |    |   |   |    |   |    |   |    |   |    |   |    |   |    |   |    |   |    |   |    |   |    |    |    |  |  |  |
| 6      | 22         |   |      |  |          |   |    |   |   |    |   |    |   |    |   |    |   |    |   |    |   |    |   |    |   |    |   |    |    |    |  |  |  |
| 7      | 24         |   |      |  |          |   |    |   |   |    |   |    |   |    |   |    |   |    |   |    |   |    |   |    |   |    |   |    |    |    |  |  |  |
| 8      | 26         |   |      |  |          |   |    |   |   |    |   |    |   |    |   |    |   |    |   |    |   |    |   |    |   |    |   |    |    |    |  |  |  |
| 9      | 28         |   |      |  |          |   |    |   |   |    |   |    |   |    |   |    |   |    |   |    |   |    |   |    |   |    |   |    |    |    |  |  |  |
| 10     | 30         |   |      |  |          |   |    |   |   |    |   |    |   |    |   |    |   |    |   |    |   |    |   |    |   |    |   |    |    |    |  |  |  |
|        |            |   |      | Ohne Griff<br>without handle<br>sans manche<br>sin mango<br>senza manico |          |   |    |   |   |    |   |    |   |    |   |    |   |    |   |    |   |    |   |    |   |    |   |    |    |    |  |  |  |
|        |            |   |      | 52-2700-06 - 52-2700-30  |          |   |    |   |   |    |   |    |   |    |   |    |   |    |   |    |   |    |   |    |   |    |   |    |    |    |  |  |  |
| 8220   | 52-2660-01 | aspiration tube for fume evacuation in  | 01   |  |          |   |    |   |   |    |   |    |   |    |   |    |   |    |   |    |   |    |   |    |   |    |   |    |    |    |  |  |  |
| 8221   | 52-2701-06 | lar.mirr.w'out hdl.fig.000/6mm  | 01   |  |          |   |    |   |   |    |   |    |   |    |   |    |   |    |   |    |   |    |   |    |   |    |   |    |    |    |  |  |  |
| 8222   | 52-2701-08 | lar.mirr.w'out hdl.fig.00/ 8mm  | 01   |  |          |   |    |   |   |    |   |    |   |    |   |    |   |    |   |    |   |    |   |    |   |    |   |    |    |    |  |  |  |
| 8223   | 52-2701-10 | lar.mirr.w'out hdl.fig. 0/10mm  | 01   |  |          |   |    |   |   |    |   |    |   |    |   |    |   |    |   |    |   |    |   |    |   |    |   |    |    |    |  |  |  |
| 8224   | 52-2701-12 | lar.mirr.w'out hdl.fig. 1/12mm  | 01   |  |          |   |    |   |   |    |   |    |   |    |   |    |   |    |   |    |   |    |   |    |   |    |   |    |    |    |  |  |  |
| 8225   | 52-2701-14 | lar.mirr.w'out hdl.fig. 2/14mm  | 01   |  |          |   |    |   |   |    |   |    |   |    |   |    |   |    |   |    |   |    |   |    |   |    |   |    |    |    |  |  |  |
| 8226   | 52-2701-16 | lar.mirr.w'out hdl.fig. 3/16mm  | 01   |  |          |   |    |   |   |    |   |    |   |    |   |    |   |    |   |    |   |    |   |    |   |    |   |    |    |    |  |  |  |

#### ABD MIDEAST GENERAL TRADING

Level 41, Emirates Towers Sheikh Zayed Road. Dubai, UAE PO Box 31303  
Tel: +971 4 319 7867  
Fax: +971 4 319 7897



Click for Links

| Item # | Model #    | Description  | QTY | U/P (SR) | T/P (SR) |
|--------|------------|--|-----|----------|----------|
| 8227   | 52-2701-18 | lar.mirr.w'out hdl.fig. 4/18mm   | 01  |          |          |
| 8228   | 52-2701-20 | lar.mirr.w'out hdl.fig. 5/20mm   | 01  |          |          |
| 8229   | 52-2701-22 | lar.mirr.w'out hdl.fig. 6/22mm   | 01  |          |          |
| 8230   | 52-2701-24 | lar.mirr.w'out hdl.fig. 7/24mm   | 01  |          |          |
| 8231   | 52-2701-26 | lar.mirr.w'out hdl.fig. 8/26mm   | 01  |          |          |
| 8232   | 52-2701-28 | lar.mirr.w'out hdl.fig. 9/28mm   | 01  |          |          |
| 8233   | 52-2701-30 | lar.mirr.w'out hdl.fig.10/30mm   | 01  |          |          |
| 8234   | 52-2703-06 | lar.mirror w.handl.fig.000/ 6 mm 19,5 cm   | 01  |          |          |
| 8235   | 52-2703-08 | lar.mirror w.handl.fig.00/ 8mm 19,5 cm   | 01  |          |          |
| 8236   | 52-2703-10 | lar.mirror w.handl.fig. 0/10mm 19,5 cm   | 01  |          |          |
| 8237   | 52-2703-12 | lar.mirror w.handl.fig. 1/12mm 19,5 cm   | 01  |          |          |
| 8238   | 52-2703-14 | lar.mirror w.handl.fig. 2/14mm 19,5 cm   | 01  |          |          |
| 8239   | 52-2703-16 | lar.mirror w.handl.fig. 3/16mm 19,5 cm   | 01  |          |          |
| 8240   | 52-2703-18 | lar.mirror w.handl.fig. 4/18mm 19,5 cm   | 01  |          |          |
| 8241   | 52-2703-20 | lar.mirror w.handl.fig. 5/20mm 19,5 cm   | 01  |          |          |
| 8242   | 52-2703-22 | lar.mirror w.handl.fig. 6/22mm 19,5 cm   | 01  |          |          |
| 8243   | 52-2703-24 | lar.mirror w.handl.fig. 7/24mm 19,5 cm   | 01  |          |          |
| 8244   | 52-2703-26 | lar.mirror w.handl.fig. 8/26mm 19,5 cm   | 01  |          |          |
| 8245   | 52-2703-28 | lar.mirror w.handl.fig. 9/28mm 19,5 cm   | 01  |          |          |
| 8246   | 52-2703-30 | lar.mirror w.handl.fig.10/30mm 19,5 cm   | 01  |          |          |
| 8247   | 52-2704-12 | handle for laryngeal mirrors<br>   | 01  |          |          |
| 8248   | 52-2706-10 | handle laryng.mirr.later.screw<br> | 01  |          |          |





#### ABD MIDEAST GENERAL TRADING

Level 41, Emirates Towers Sheikh Zayed Road. Dubai, UAE PO Box 31303  
Tel: +971 4 319 7867  
Fax: +971 4 319 7897

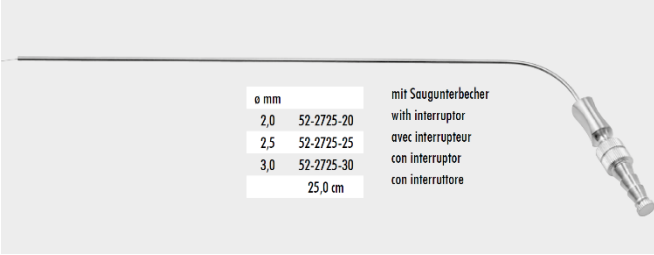

Click for Links



| Item # | Model #    | Description   | QTY | U/P (SR) | T/P (SR) |
|--------|------------|---|-----|----------|----------|
| 8249   | 52-2725-20 | aspirating tube with interruptor<br>  | 01  |          |          |
| 8250   | 52-2725-25 | aspirating tube with interruptor  | 01  |          |          |
| 8251   | 52-2725-30 | aspirating tube with interruptor  | 01  |          |          |
| 21     | LU70C      | Laryngoscope Autoclavable<br>منظار حنجري صلب<br><br>VIDEO PDF Brochure <a href="#">CLICK</a><br>▪ Laryngoscope $\varnothing$ 7.0 mm, l=190 mm, 70°, autoclavable<br>Manufacturer: EMOS Technology GmbH – Germany    | 01  |          |          |
| 22     | LU70D      | Laryngoscope Autoclavable<br>منظار حنجري صلب<br><br>VIDEO PDF Brochure <a href="#">CLICK</a><br>▪ Laryngoscope $\varnothing$ 7.0 mm, l=190 mm, 90°, autoclavable<br>Manufacturer: EMOS Technology GmbH – Germany  | 01  |          |          |

| Item # | Model # | Description   | QTY | U/P (SR) | T/P (SR) |
|--------|---------|---|-----|----------|----------|
| 23     | LS40CUD | <p><b>Micro Laryngoscope HD Autoclavable</b></p> <p>منظار حنجري صلب للأطفال</p>  <p>   <b>Brochure</b>  </p> <ul style="list-style-type: none"> <li>Laryngoscope <math>\varnothing</math> 4.0 mm, l=175 mm, 70°, autoclavable</li> </ul> <p>Manufacturer: EMOS Technology GmbH – Germany </p> | 01  |          |          |

Thank you for your order

### Terms & Conditions

**Warranty** : One Year against manufacturing defects  
**Payment** : 50 % Advance payment with order  
: 50 % Before delivery

Best Regards,



### ABD MIDEAST GENERAL TRADING

Level 41, Emirates Towers Sheikh Zayed Road. Dubai, UAE PO Box 31303  
Tel: +971 4 319 7867  
Fax: +971 4 319 7897



Click for Links